



User Manual

**90LM190E1FHA0F
Open Frame Touchmonitor**

FCC Compliance Statement

This device complies with part 15 of the FCC Rules. Operation is subject to the following two conditions:

1. This device may not cause harmful interference, and
2. This device must accept any interference received, including interference that may cause undesired operation.

FCC WARNING

This equipment has been tested and found to comply with the limits for a Class B digital device, pursuant to Part 15 of the FCC Rules. These limits are designed to provide reasonable protection against harmful interference in a residential installation.

This equipment generates uses and can radiate radio frequency energy and, if not installed and used in accordance with the instructions, may cause harmful interferences to radio communications.

However, there is no guarantee that interference will not occur in a particular installation. If this equipment does cause harmful interference to radio or television reception, which can be determined by turning the equipment off and on, the user is encouraged to try to correct the interference by one or more of the following measures:

- Reorient or relocate the receiving antenna.
- Increase the separation between the equipment and the receiver.
- Connect the equipment into an outlet different from that to which the receiver is connected.
- Consult the dealer or an experienced radio/TV technician for help.

Caution:

To comply with the limits for an FCC Class B computing device, always use the shielded signal cord supplied with this unit.

The Federal Communications Commission warns that changes or modifications of the unit not expressly approved by the party responsible for compliance could void the user's authority to operate the equipment.

CE mark for Class B ITE (Following European standard EN55022/1998; EN61000-3-2/1995; EN61000-3-3/1995, EN55024/1998, EN60950/1992+A1+A2+A3+A4+A11)

Radio Frequency Interference Statement

Warning:

This is a Class B product. In a domestic environment, this product may cause radio interference in which case the user may be required to take adequate measures.

Canadian Doc Notice

For Class B Computing Devices

This digital apparatus does not exceed the Class B limits for radio noise emissions from digital apparatus as set out in the Radio Interference Regulation of the Canadian Department of Communications.

"Le présent appareil numérique n'émet pas de bruits radioélectriques dépassant les limites applicables aux appareils numériques de la class B prescrites dans le Règlement sur le brouillage radioélectrique édicté par le ministère des Communications du Canada."

TABLE OF CONTENTS

Your New Touchmonitor	4
Unpacking	4
Identifying Components	4
Connecting Power and Cables	5
Power Management System	6
The Touchmonitor's Control Panel	6
Adjusting the Touchmonitor's Display	6
Open Frame Touchmonitor Specifications	9
Supported Timing	9
Troubleshooting	10



The Open Frame Touchmonitor

Your New Touchmonitor

Your Touchmonitor has been designed to be versatile, ergonomic and user-friendly. The Touchmonitor is capable of displaying most standards, from 640x400 VGA to 1280x1024 SXGA. The digital controls allow the user to easily adjust the Touchmonitor's display parameters.

Unpacking

Before unpacking your Touchmonitor, prepare a suitable workspace for it and your computer system. Look for a stable, level and clean surface near a wall outlet.

After unpacking your Touchmonitor, make sure the following items are included in the box and are in good condition:

- 19inch Open Frame Touchmonitor
- Accessory Box
- Power Cord
- AC to DC Adapter
- Monitor-To-PC Analog signal cable 15pin
- Monitor-To-PC DVI signal cable
- RS232 Cable
- USB Cable
- OSD Board With Cable
- Terminal Connector
- Touch Driver CD
- This User Manual

If you find that any item is missing or appear to be damaged, contact your dealer immediately. Do not throw away the packing material or shipping carton in case you need to ship or store the Touchmonitor in the future.

Identifying Components

A. The Touchmonitor — Front View

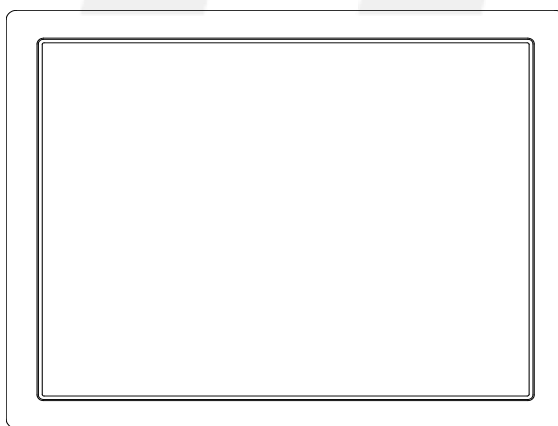

Figure 1-1: The Touchmonitor Front View

1. Touchmonitor Screen

The Touchmonitor screen is a 19inch TFT 1280 x 1024 screen.

2. Touchmonitor Control Panel

Refer to [The Display controls](#) for more details.

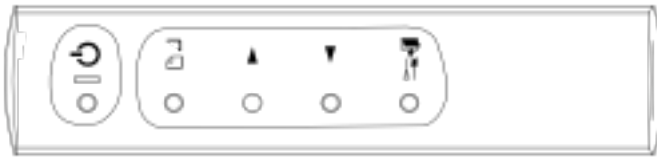

B. "Hot Keys" for Quick Adjustment of Touchmonitor Settings

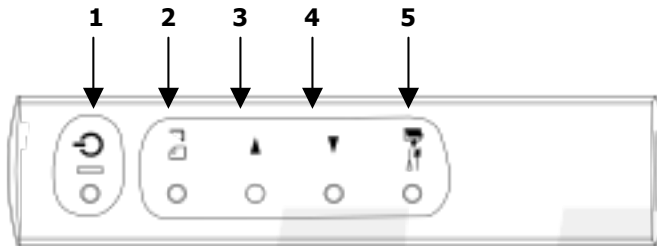







Figure 1-2: "Hot Keys"

<p>1. Brightness Adjustment "hot key": Press this ◀ & ▶ buttons to allow you to adjust the Brightness of the LCD Monitor directly</p>	 
<p>2. Source select " Hot key" Press this  button to switch between DVI and RGB automatically.</p>	 →  OR 

Connecting Power and Cables

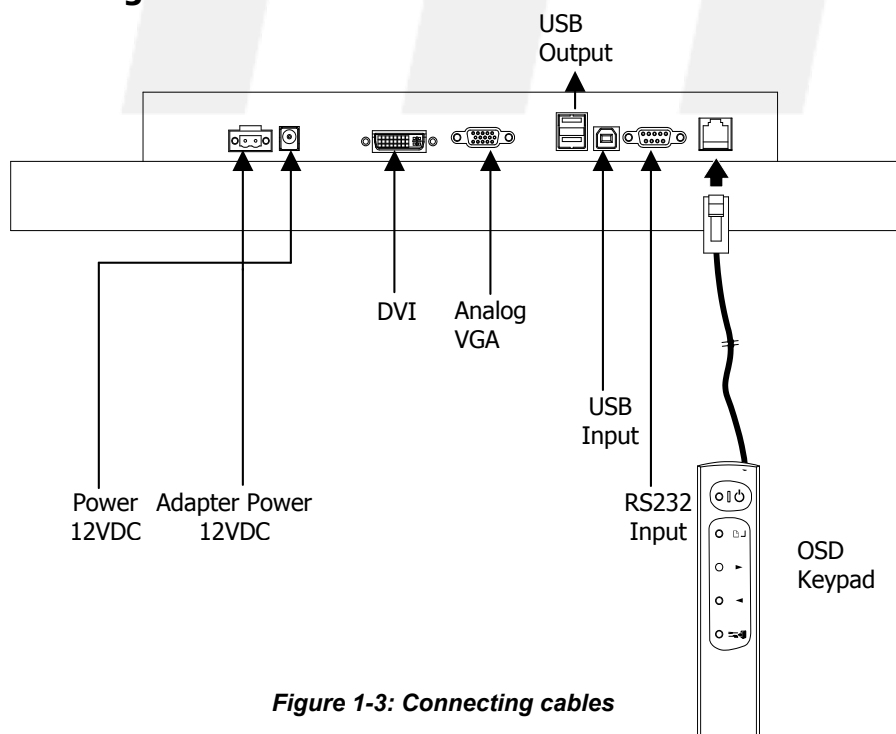

Figure 1-3: Connecting cables

Power Management System

This Touchmonitor complies with the VESA DPMS power management proposal. When the Touchmonitor is in power-saving mode or detects an incorrect timing, the display will be blank and the Power LED indicator changes from blue to red.

The Display Controls

The Touchmonitor's Control Panel

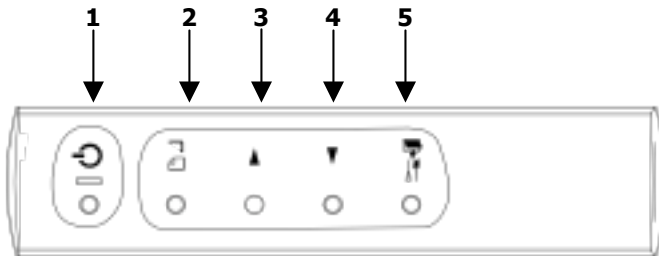













Figure 1-4: The Control Panel

- 1.  : Power Switch**
Use the power switch to turn ON or OFF power. We recommend turning your system power on first, then the Touchmonitor.
- 2.  : Menu button**
Enable the OSD Menu / Enter into the sub- menu.
- 3.  : Move the cursor to the Right**
When OSD is enabled, increases the value.
- 4.  : Move the cursor to the Left**
When OSD is enabled, decreases the value.
- 5.  : Exit OSD button**
When OSD is enabled / Input source select (hot key)























Adjusting the Touchmonitor's Display

















OSD Main Menu

- Pressing the  button causes the screen below to appear
- Use the  &  key to select the desired group, then press  to enter into sub-menu
- Repeat step 2 to select the changed item, then  &  to change the value.



Auto Adjust Option

	The Auto Adjust option lets the monitor determine and select the settings that are most appropriate for your system requirements. Note: it only apply for Analog RGB input
	Provides you with the current display timing information
	Brightness and Contrast Adjustment
	Adjusts the Brightness value
	Adjusts the Contrast value
	Return to the previous Menu
	Color Temperature Adjustment
	Enables or disables the sRGB values
	User Mode: Changes the RGB color values
	Execute the white balance function
	Red: Change Red gain for the color temperature
	Green: Change Green gain for the color temperature
	Blue: Change Blue gain for the color temperature
	Return to the previous Menu
	Sets the color temperature to 6500K
	Sets the color temperature to 9300K
	Return to the previous Menu
	Display Quality Adjustment
	Auto Adjust: use this option to apply automatically setting
	Changes the screen viewing size
	Adjusts phase tracking to reduce display flicker
	Moves the whole screen right or left
	Moves the whole screen up or down

	Return to the previous Menu
	OSD Adjustment
	Restores settings to factory default values
	OSD parameter setting
	Sets the OSD timer
	Moves the OSD menu horizontally
	Moves the OSD menu vertically
	Return to the previous Menu
	Set the graphic mode or text mode
	Enable the 720x400 text mode
	Enable the 640x400 graphic mode
	Return to the previous Menu
	Analog and Digital signal select
	Select Analog signal
	Select Digital signal
	Return to the previous Menu
	Exit the OSD screen

Note:

1) No video

When the Touchmonitor is ON and there is no video signal received, the following message will be displayed



2) Signal out of range

When the frequency range of the signal is out of the Touchmonitor's specifications, (over 85HZ) the display will show the following message

Out of Range

Appendix A

Open Frame Touchmonitor Specifications

LCD Panel	19" SXGA	
Control Functions Power	Software Power switch with LED indicator (ON/OFF)	
On-Screen Display (OSD)	Main Menu	Submenu
	Brightness and Contrast	Brightness, Contrast, Exit
	Color Temperature Adjustment	sRGB, User Mode, White Balance, Color R,G & B Adjust, 6500K, 9300K, Exit
	Display Quality Adjustment	Auto Adjust, Pixel Clock, Phase, H position, V position, Exit
	OSD Adjustment	Load Default , OSD Timer, OSD H/V Position, Text mode, Graphic mode, Exit
	Analog and Digital Signal Select	VGA mode, DVI mode, Exit
Display Area (mm)	376.32 x 301.06 (19" diagonal)	
Display Colors	16.7 M	
Video Interface	VGA Compatible Analog RGB, Digital DVI interface	
Scanning Frequency H/V	24-80K/50-75Hz	
Power Management	Meets VESA DPMS	
Power Consumption	35W/1W Max.	
Dimensions (W x H x D)	435 x 361 x 64mm	
Net Weight (approx.)	9 Kg	
Power Supply	100 ~ 240V; 60/50Hz (Auto Sensing)	
Environment	Operating Temperature: 32 to 104°F (0 to 40° C) Relative Humidity: 10% to 90%	
Regulatory	CE, FCC, cUL, TUV,	

Appendix B

Supported Timing

Item	Standards	Resolution	Dot Clock (MHz)	Vertical Scanning Frequency (Hz)	Horizontal Scanning Frequency (kHz)
1	NEC PC98	640x400	21.05	56.42	24.83
2	MAC 13" mode	640x480	30.24	66.67	35.00
3	MAC 16" mode	832x624	57.28	74.55	49.73
4	MAC 17" mode	1024x768	80.00	75.02	60.24
5	VGA	640x350	25.18	70.09	31.47
6	VGA	640x400	25.18	70.09	31.47
7	VGA	640x480	25.18	59.94	31.47
8	VESA	640x480	31.50	72.81	37.86
9	VESA	640x480	31.50	75.00	37.50
10	VESA	800x600	36.00	56.25	35.16
11	SVGA	800x600	40.00	60.32	37.88
12	VESA	800x600	50.00	72.19	48.08
13	VESA	800x600	49.50	75.00	46.88
14	VGA	720x400	28.32	70.09	31.47
15	XGA	1024x768	65.00	60.00	48.36
16	VESA	1024x768	75.00	70.07	56.48
17	VESA	1024x768	78.75	75.03	60.02
18	VESA	1280x1024	108	60	63.98
19	VESA	1280x1024	135	75	80

*Once a mode is optimized, there is no need to make any further adjustment as long as the VGA card remains unchanged.

*Specifications are subject to change without notice.

Troubleshooting

This Touchmonitor comes pre-adjusted with standard VGA timing. Due to output timing differences among various VGA cards, you may initially experience an unstable or unclear display when a new display mode or new VGA card is selected. Before applying any of the following troubleshooting procedures, you should first apply the Auto Adjust option in the OSD menu.

PROBLEM: Display is unclear or unstable

To stabilize or clarify your display, open the OSD and adjust the Clock and Phase to obtain a clear display

PROBLEM: There is no Screen Display

If there is no display on the Touchmonitor, refer to the following:

1. Make sure that the power indicator on the Touchmonitor is lit, that all connections are secure, and that the system is running on the correct timing. Refer to Appendix B for information on timing.
2. Turn off the Touchmonitor and then turn it back on again. Press the OSD Menu button (refer to [The Display Controls](#)) once and then press one of the Adjustment Control buttons several times. If there is still no display, press the other Adjustment Control button several times.
3. If step 2 does not work, connect your PC system to another external Display. If your PC system functions properly with another Display but it do not function with the Touchmonitor, and the Touchmonitor's power LED is blinking, the output timing of the PC's VGA card may be out of the Touchmonitor's synchronous range. Change to one of the alternate modes listed in Appendix B, or replace the VGA card and repeat steps 1 and 2.
4. If the power LED is not lit, check that the AC power connector is securely connected, and verify that the AC adapter LED is lit. If the AC adapter LED is not lit, please contact your dealer for assistance.

PROBLEM: The Touchmonitor displays "Out of Range" error message

1. If you have a CRT monitor, please connect the CRT monitor to the computer and change the refresh rate down to 60hz via your video card's display settings menu. After the setting of 60hz has been changed, you can then use the Touchmonitor with the computer.
2. If you do NOT have a CRT monitor, please make sure both the Touchmonitor and your computer are turned off. Afterwards, turn on the Touchmonitor and the computer.
3. While the computer is turned on, press the "F8" key on your keyboard continuously until a selection menu appears and select the "Safe Mode" option.
4. When you've entered Safe Mode please uninstall any video card driver and Touchmonitor driver by using either the "Add / Remove Programs" icon or going into "System Properties" and manually removing anything under "Monitors" and "Display Adapters".
5. After removing all the drivers, please reboot your computer and you should be able to see Windows. Please proceed to install your Touchmonitor driver first, then your video card driver. Please remember to make sure your refresh rate should be at 60hz.